

产品使用说明书

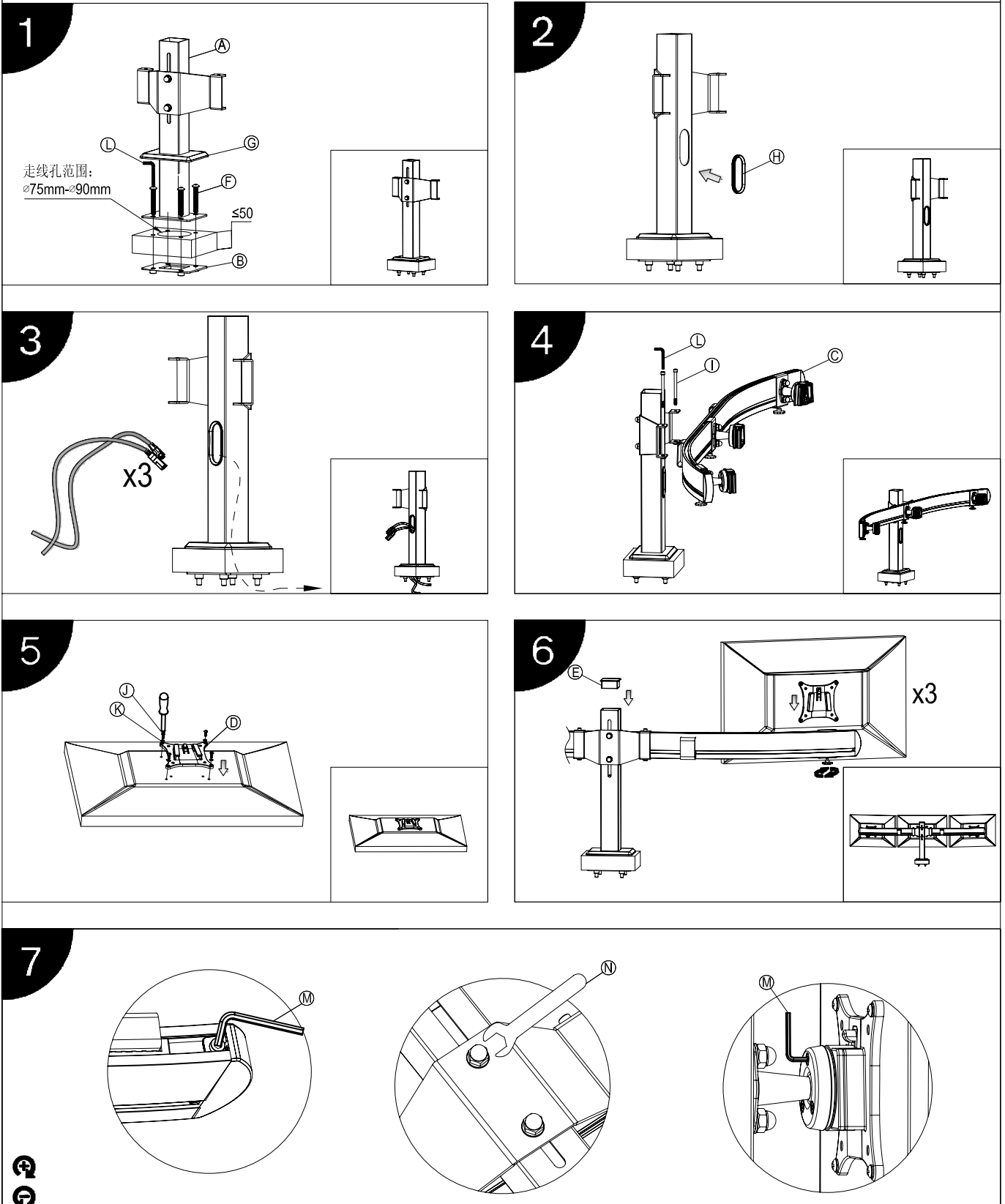







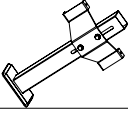
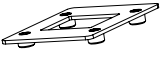

产品型号: BL300

安装步骤

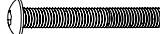
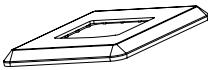

产品使用说明书

产品型号: BL300

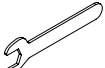
标准配件			
序号	示图	规格	数量
A			1
B			1
C			1
D			3
E			1
F		M8*65	4
G			1
H			1
I		M6*80	2
J		M4*12	12
K		M4	12
L		M5	1
M		M3	1
N		M8	1