

## 产品使用说明书

产品型号: L100

### 安装步骤

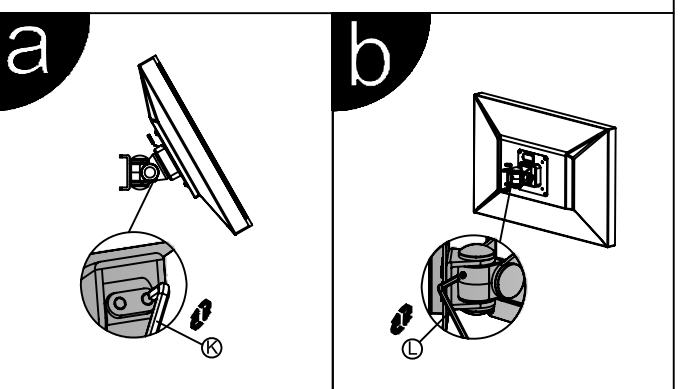
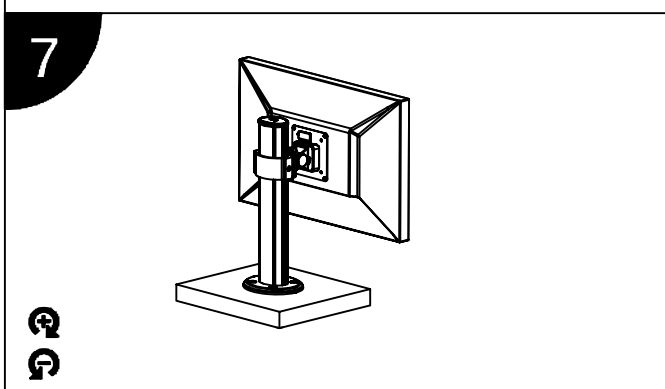
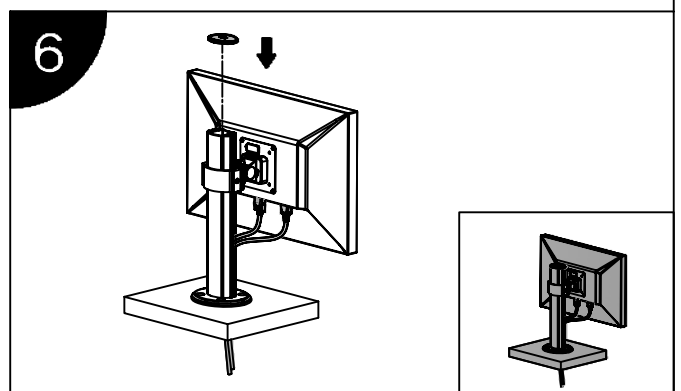
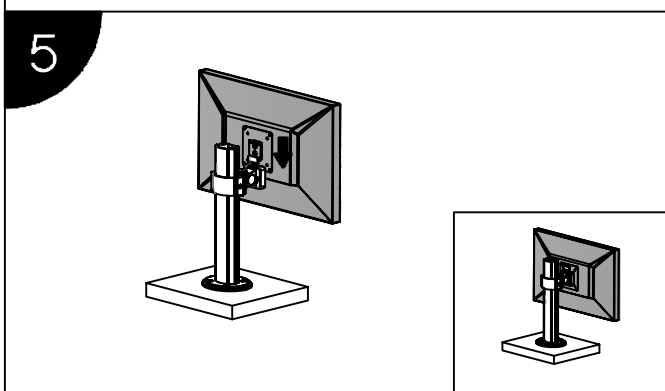
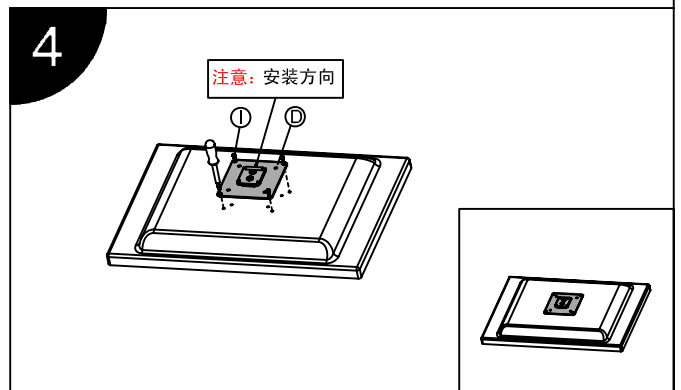
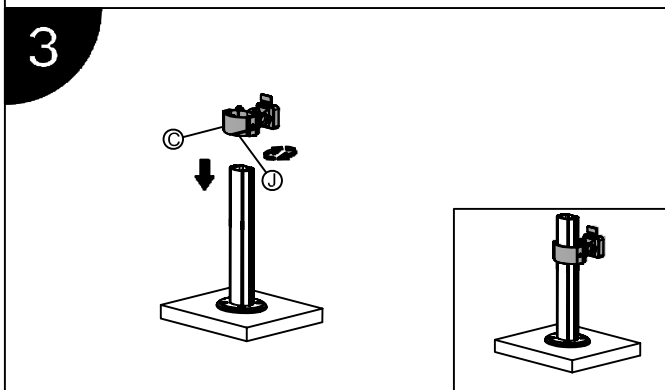
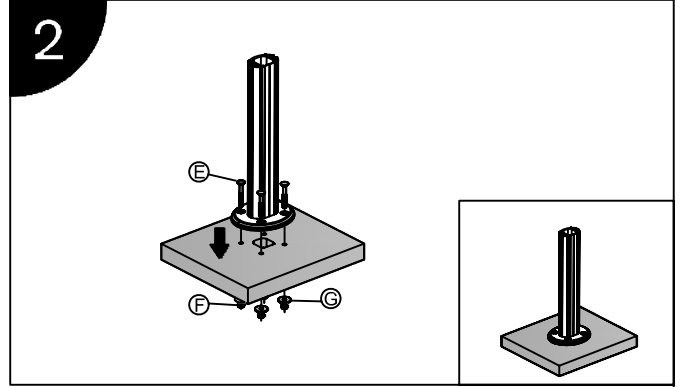
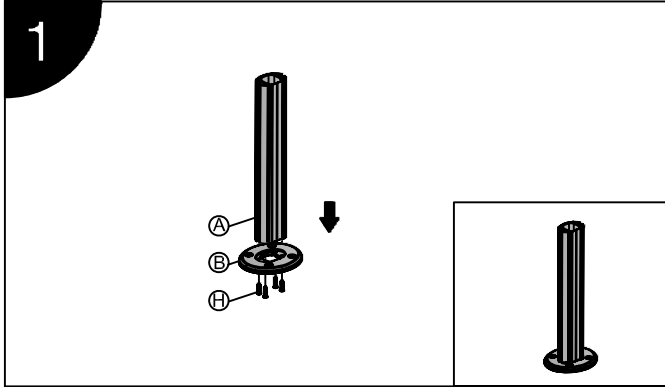

# 产品使用说明书

产品型号：L100

标准配件			
序号	示图	规格	数量
A			1
B			1
C			1
D			1
E		M8*60	4
F		M8螺帽	4
G		M8垫片	4
H		M5*25	4
I		M4*12	4
J		M5	1
K		M4	1
L		M3	1