

产品使用说明书

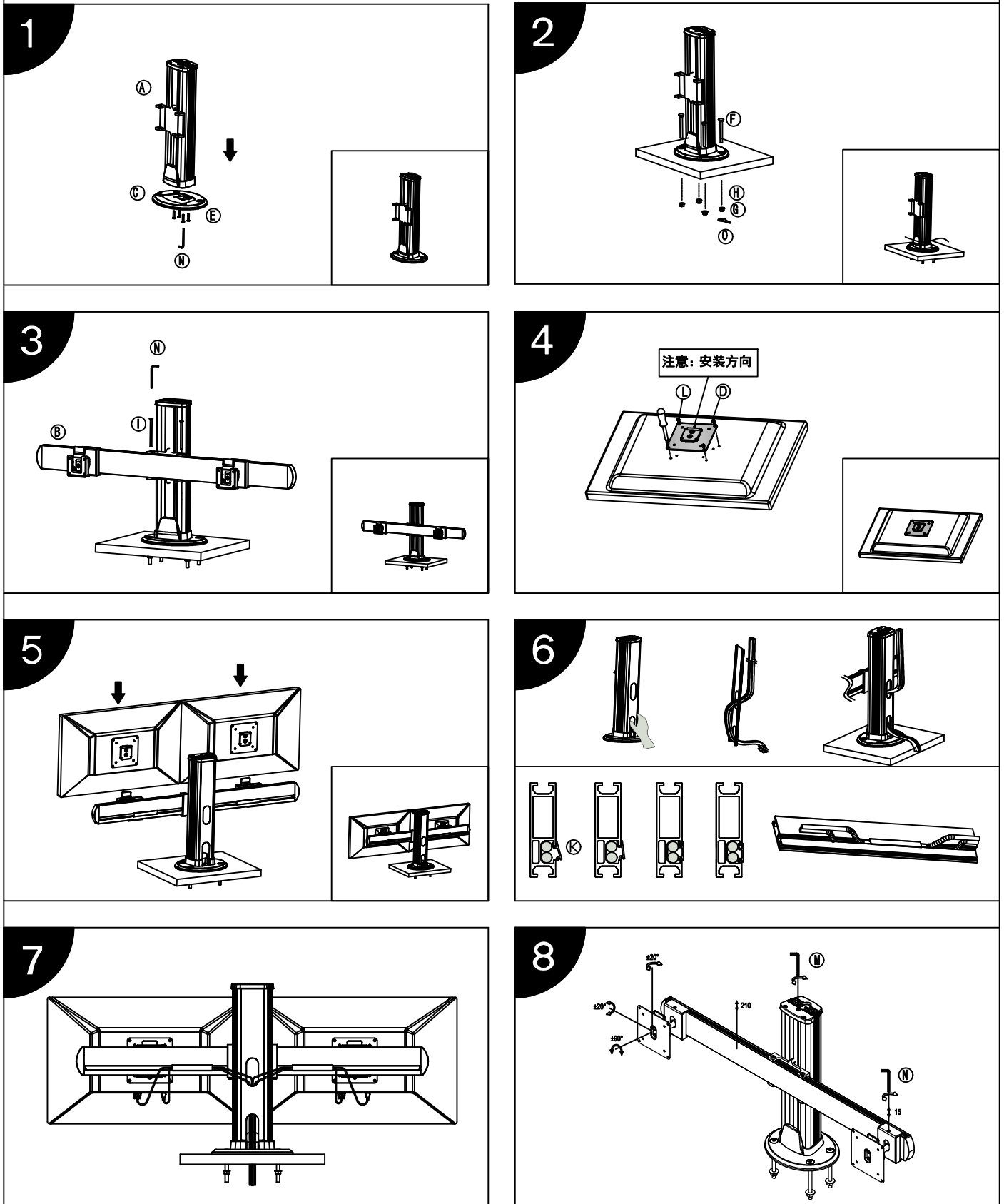









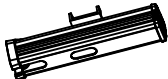
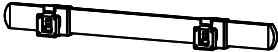

产品型号：CL203

安装步骤

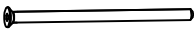

产品使用说明书

产品型号：CL203

标准配件			
序号	示图	规格	数量
A		CL0502	1
B		CL0102	1
C		CL0601	1
D		S100-1000	2
E		M5*25	4
F		M8*80	4
G		M8螺帽	4
H		M8垫片	4
I		FH-7991-5*80	2
 			
K		CL-AL-15-100	2
L		M4*12	8
M		M5	1
N		M3	1
O		E-FE-16	1