

# 产品使用说明书

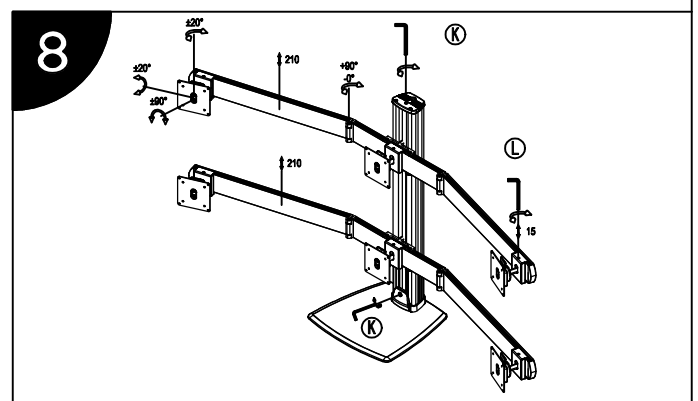

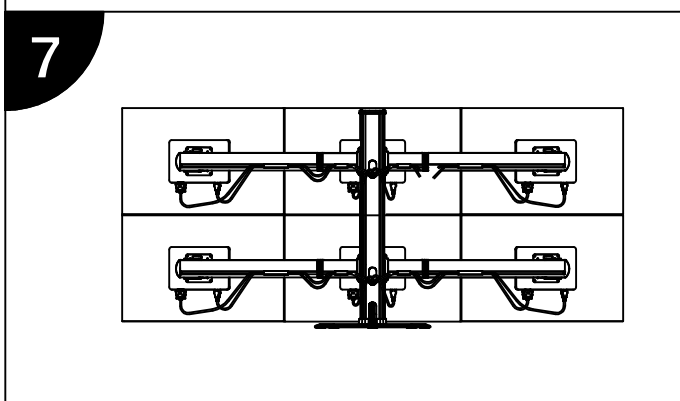

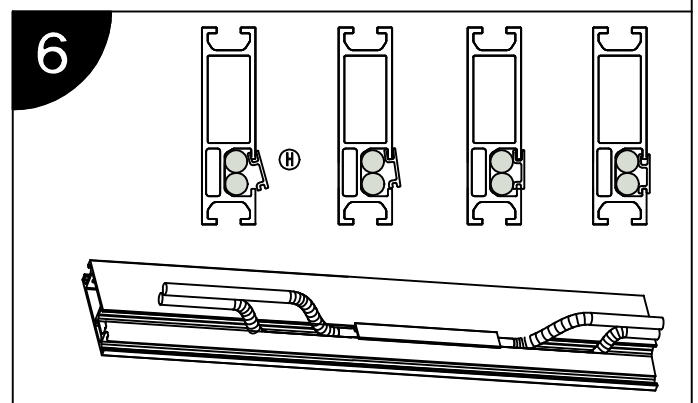

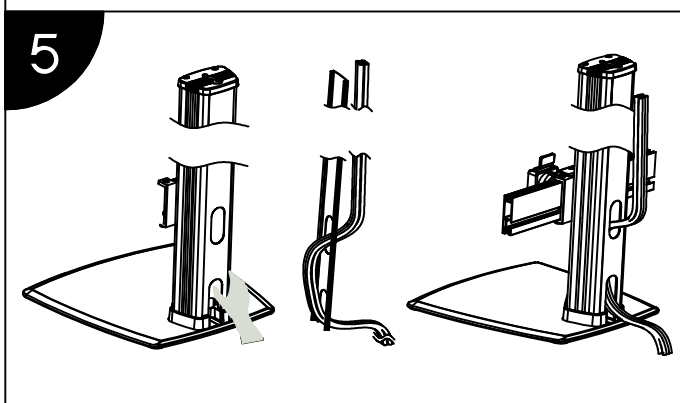
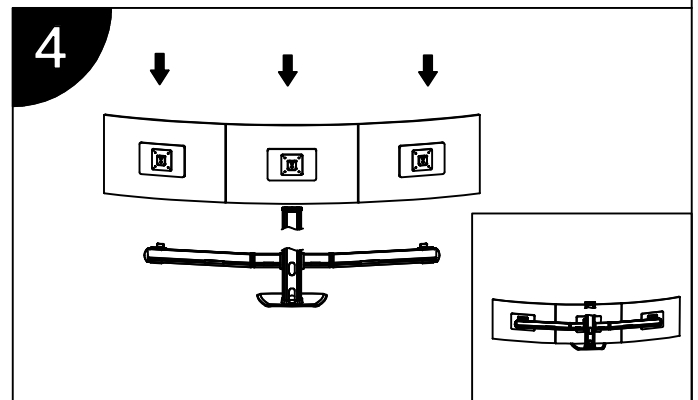
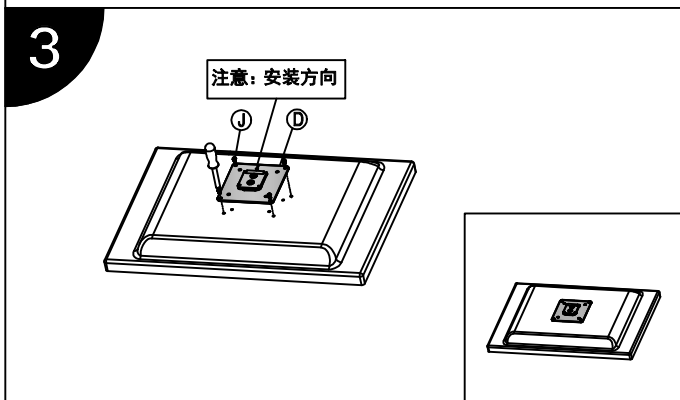
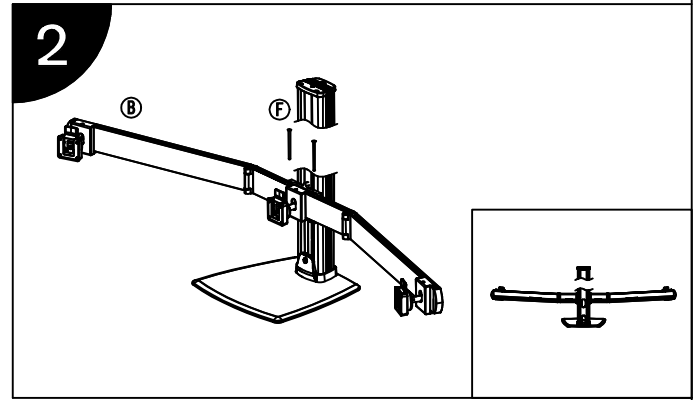
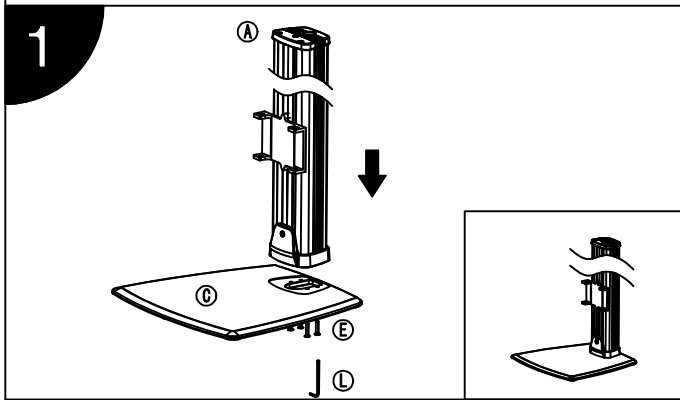

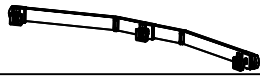

产品型号：CL601

## 安装步骤

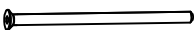

# 产品使用说明书

产品型号：CL601

标准配件			
序号	示图	规格	数量
A		CL0504	1
B		CL0103	2
C		CL0602	1
D		S100-1000	6
E		M5*25	4
F		FH-7991-5*80	4
/			
H		CL-AL-15-50	4
I		CL-AL-15-100	4
J		M4*12	24
K		M5	1
L		M3	1